

PRO-60 HP PRO-110 HP

TRAGBARER HYDRAULIK-LOCHSTANZER



Eigenschaften und Vorteile:

- Double Action - voll automatischer Stanzprozess und Rückführung
- Stanzbereich Lochdurchmesser bis 27 mm
- moderne Konstruktion
- intelligentes Kontrollsystem mit Justierung und automatischer Krafterkennung
- Lichtanzeige Modus
- Schutz gegen unbeabsichtigtes Starten
- Einfache Handhabung auch in schwierigen Positionen
- Alle Verbindungsteile sind rückwärtig gelegen
- Breites Spektrum an formspezifischen Stanzen und Stempel
- patentierte kompakte mobile Hydraulik-Powerstation
- Einzigartiges Krangerüst Stanzstation erhöht die Produktivität und Bedienercomfort

							
	max. Blechstärke	max. Ansatzlänge	max. Lochdurchmesser	max. Längsloch	Stanzzeit	Stanzkraft	hydraulische Double Action

PRO-60 HP	13 mm	60 mm	27 mm	25 x 18 mm	5 sec	35 ton	JA
PRO-110 HP	16 mm	110 mm	27 mm	25 x 18 mm	8 sec	47 ton	JA

Technische Spezifikationen	Modell PRO 60 HP	Modell PRO-110 HP
max. Ansatzlänge	60 mm	110 mm
max. Lochdurchmesser	Ø 27 mm	Ø 27 mm
max. Längsloch	25 x 18 mm	25 x 18 mm
Stanzzeit	5 sec	8 sec
max. Blechstärke	13 mm	16 mm
Stanzkraft	35 ton	47 ton
Arbeitsdruck	700 bar	700 bar
Gewicht	20 kg	35 kg
Produktcode	GLW-0522-10-00-00-1	GLW-0507-10-00-00-0



Arbeiten in vertikaler und horizontaler Position

Double-Action Hydraulikstation Modell HPP 700/1.5	
Stromversorgung*	230V/50Hz; 115V/60Hz
Leistung	2000 W
Arbeitsdruck	700 bar
Pumpleistung	1.5 L/min
Ölkapazität	10 L
Produktcode	ZSL-0517-10-20-00-0 HPP-700/1,5 / 220-240V/50Hz

* Kontaktieren Sie Promotech für andere Stromoptionen



tragbare Hydraulikstation mit Ablage zum Transport der Lochstanze



Abmessungen

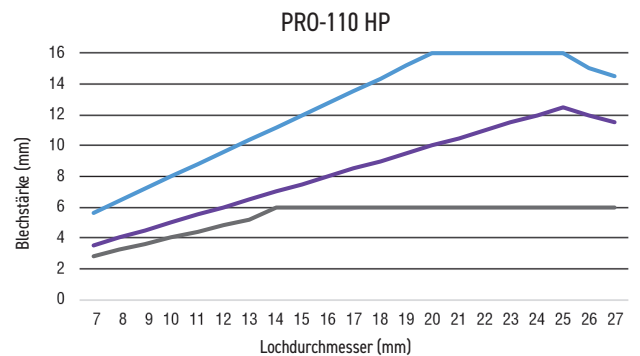
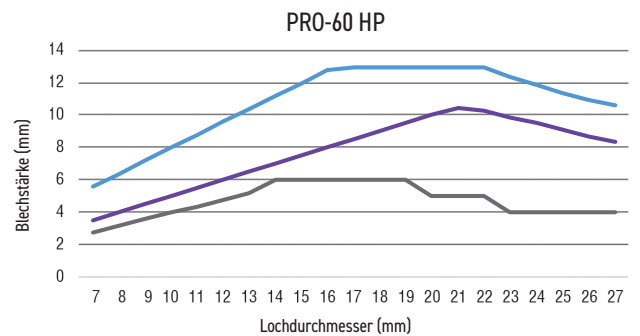
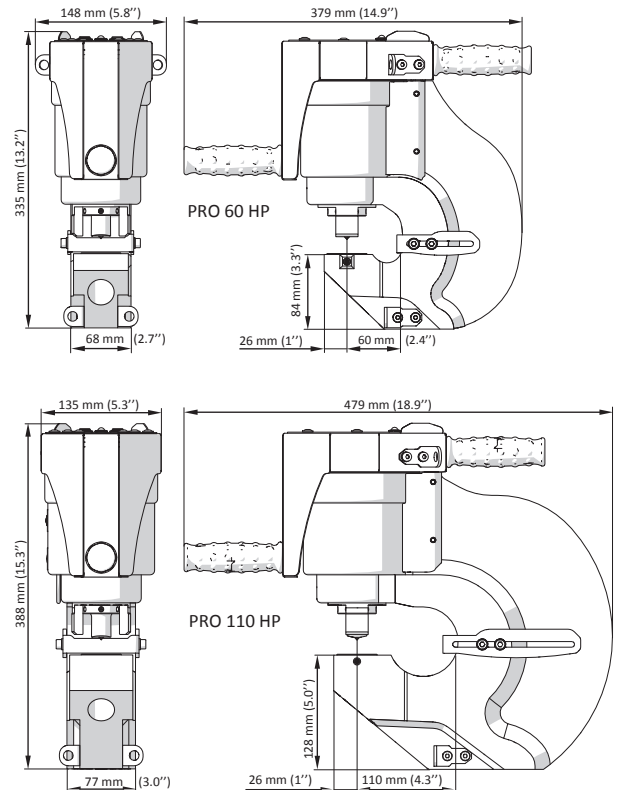

Stabilisator für PRO-60 HP, Productcode: BLN-000004
Stabilisator für PRO-110 HP, Productcode: BLN-000005

Passen Sie ihren Arbeitsplatz mit einer Auswahl an optionalem Zubehör individuell an.

Schlauchset

Produktcode: ZUR-0517-15-00-00-0



einfaches Setup und Anpassen der Höhe und Stabilisatorkontrolle.



Schlaucharm und 2 Träger mit Rädern erlauben einen einfachen Einsatz von Stanzer und Hydraulikstation als eine Einheit.

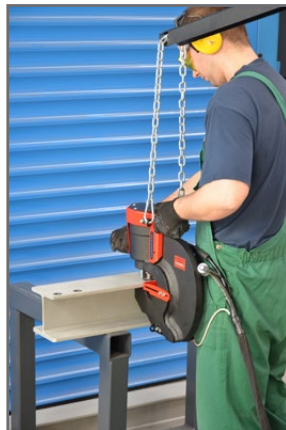

eine einzigartige Lösung, die ihre Arbeit effizient und komfortabel macht.

Rad Schlitten

Produktcode: PRW-0507-90-00-00-0

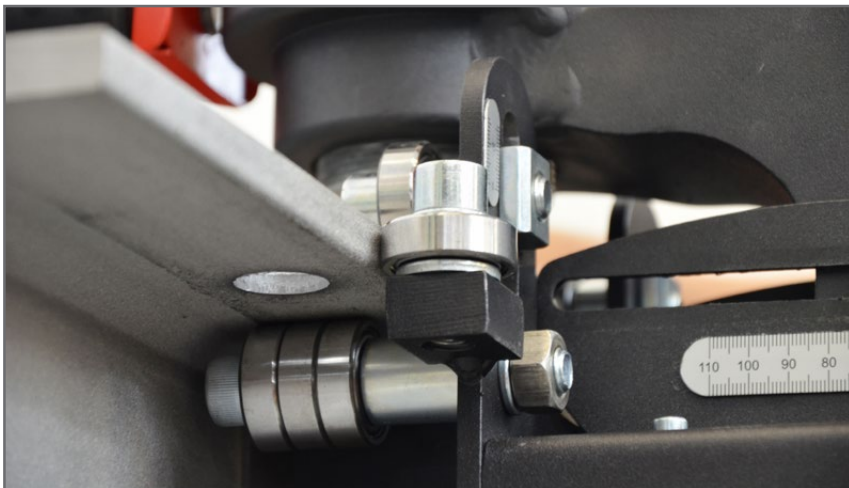

erlaubt einfaches und effizientes Bewegen entlang des Arbeitsstückes.

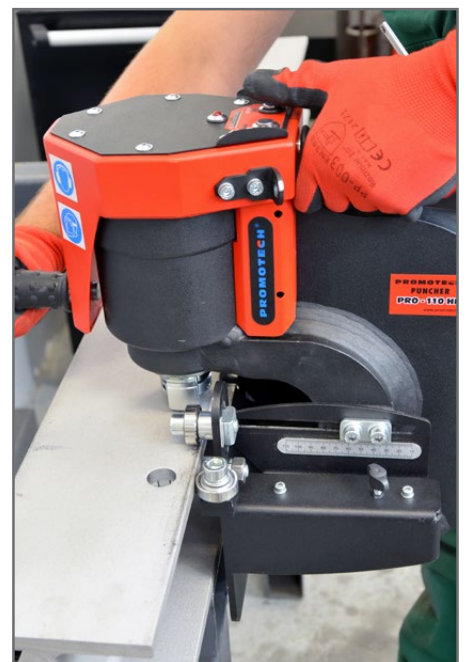

Ständer mit Fußpedal

Produktcode: ZST-0507-91-00-00-0



Sie benötigen weder einen Stabilisator noch eine Schlaucharm, um den Stanzer in Position zu halten.

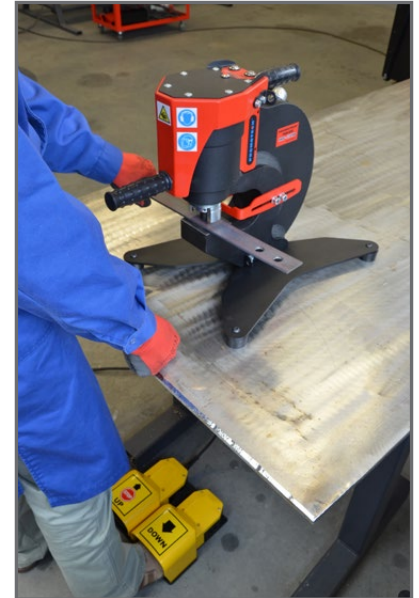

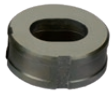

Fußschaltersteuerung ermöglicht Freihandbetrieb in der Tischposition.

Stempel und Matrizen

Werkzeuge Hydrauliktanzanzen		
Ablängen [mm]	Stempel - Produktcode	Matrizen - Produktcode
16x8	STM-0507-30-13-00-0	MTY-0507-70-13-00-0
18x9	STM-0507-30-12-00-0	MTY-0507-70-12-00-0
18x11	STM-0507-30-11-00-0	MTY-0507-70-11-00-0
20x10	STM-0507-30-10-00-0	MTY-0507-70-10-00-0
20x12	STM-0507-30-09-00-0	MTY-0507-70-09-00-0
20x14	STM-0507-30-08-00-0	MTY-0507-70-08-00-0
22x11	STM-0507-30-07-00-0	MTY-0507-70-07-00-0
22x14	STM-0507-30-06-00-0	MTY-0507-70-06-00-0
24x12	STM-0507-30-05-00-0	MTY-0507-70-05-00-0
25x9	STM-0507-30-04-00-0	MTY-0507-70-04-00-0
25x12	STM-0507-30-03-00-0	MTY-0507-70-03-00-0
25x13	STM-0507-30-02-00-0	MTY-0507-70-02-00-0
25x14	STM-0507-30-01-00-0	MTY-0507-70-01-00-0
25x16	STM-0507-30-17-00-0	MTY-0507-70-17-00-0
25x18	STM-0507-30-00-00-0	MTY-0507-70-00-00-0

verschiedene Werkzeuge in Zollmaßen oder metrischen Maßen auf Anfrage erhältlich

Werkzeuge Hydrauliktanzanzen			
Durchmesser [mm]	Stempel - Produktcode	Matrizen - Produktcode	Matrizen 5° - Produktcode
7	STM-0507-20-18-00-0	MTY-0507-40-18-00-0	-
8	STM-0507-20-17-00-0	MTY-0507-40-17-00-0	-
9	STM-0507-20-16-00-0	MTY-0507-40-16-00-0	MTY-0507-50-16-00-0
10	STM-0507-20-15-00-0	MTY-0507-40-15-00-0	MTY-0507-50-15-00-0
11	STM-0507-20-14-00-0	MTY-0507-40-14-00-0	MTY-0507-50-14-00-0
12	STM-0507-20-13-00-0	MTY-0507-40-13-00-0	MTY-0507-50-13-00-0
13	STM-0507-20-12-00-0	MTY-0507-40-12-00-0	MTY-0507-50-12-00-0
14	STM-0507-20-11-00-0	MTY-0507-40-11-00-0	MTY-0507-50-11-00-0
15	STM-0507-20-10-00-0	MTY-0507-40-10-00-0	MTY-0507-50-10-00-0
16	STM-0507-20-09-00-0	MTY-0507-40-09-00-0	MTY-0507-50-09-00-0
17	STM-0507-20-08-00-0	MTY-0507-40-08-00-0	MTY-0507-50-08-00-0
18	STM-0507-20-07-00-0	MTY-0507-40-07-00-0	MTY-0507-50-07-00-0
19	STM-0507-20-06-00-0	MTY-0507-40-06-00-0	MTY-0507-50-06-00-0
20	STM-0507-20-05-00-0	MTY-0507-40-05-00-0	MTY-0507-50-05-00-0
21	STM-0507-20-04-00-0	MTY-0507-40-04-00-0	MTY-0507-50-04-00-0
22	STM-0507-20-03-00-0	MTY-0507-40-03-00-0	MTY-0507-50-03-00-0
23	STM-0507-20-02-00-0	MTY-0507-40-02-00-0	MTY-0507-50-02-00-0
24	STM-0507-20-01-00-0	MTY-0507-40-01-00-0	MTY-0507-50-01-00-0
25	STM-0507-20-00-00-0	MTY-0507-40-00-00-0	MTY-0507-50-00-00-0
26	STM-0507-20-19-00-0	MTY-0507-40-19-00-0	MTY-0507-50-19-00-0
27	STM-0507-20-20-00-0	MTY-0507-40-20-00-0	MTY-0507-50-20-00-0

Änderungen der Angaben ohne vorherige Ankündigung vorbehalten. 20.09



PROMOTECH Sp. z o.o.
ul. Elewatorska 23/1, 15-620 BIAŁYSTOK, POLAND
tel. (+48 85) 678 34 05, fax (+48 85) 662 78 77
marketing@promotech.eu www.promotech.eu

Ihr Händler vor Ort:



Stuch
Schweißtechnik
www.weldingweb.de
(49) 203 7 200 200